

# **Polymak<sup>®</sup>**

## **FINSHING SANDER**

---

### **PM110SFS**

---

**INSTRUCTION MANUAL**

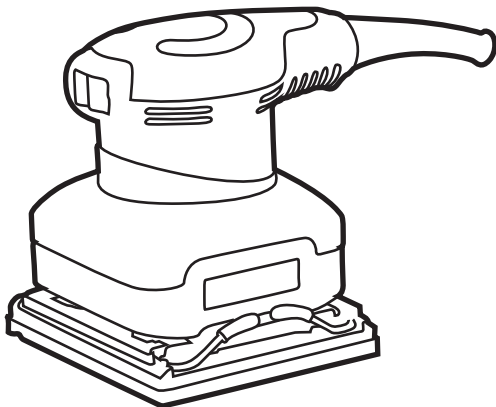

Read and follow all safety Precautions in instructions in instruction manual.

**GENERAL SAFETY WARNINGS****⚠ Warning!****Work area safety**

- a) **Keep work area clean and well lit. Cluttered and dark areas invite accidents.**
- b) **Do not operate power tools in explosive atmospheres, such as in the presence of flammable liquids, gases, or dust.** Power tools create sparks which may ignite the dust or fumes.
- c) **Keep children and bystanders. Distractions can control.**

**Electrical safety**

- a) **Power tool plugs must match the outlet. Never modify the plug in any way.** Do not use any adapter plugs with earthed (grounded) power tools. Unmodified plugs and matching outlets will reduce risk of electric shock.
- b) **Avoid body contact with earthed or grounded surfaces such as pipes, radiators, ranges, and refrigerators.** There is an increased risk of electric shock if your body is earthed or grounded.
- c) **Do not expose power tools to rain or wet conditions.** Water entering a power tool will increase the risk of electric shock.
- d) **Do not abuse the cord. Never use the cord for carrying, pulling, or unplugging the power tool.** Keep cord away from heat, oil, sharp edges or moving parts. Damaged or entangled cords increase the risk of electric shock.
- e) **When operating a power tool outdoors, use an extension cord suitable for outdoor use.** Use of a cord suitable for outdoor use reduces the risk of electric shock.
- f) **If operating a power tool in a damp location is unavoidable, use a residual current device (RCD) protected supply.** Use of an RCD reduces the risk of electric shock.

**Personal safety**

- a) **Stay alert, watch what you are doing and use common sense when operating a power tool.** Do not use a power tool while you are tired or under the influence of drugs, alcohol, or medication. A moment of inattention while

operating power tools may result in serious personal injury.

- b) **Use personal protective equipment. Always wear eye protection.** Protective equipment such as dust mask, non-skid safety shoes, hard hat, or hearing protection used for appropriate conditions will reduce personal injuries.
- c) **Prevent unintentional starting. Ensure the switch is in the off position before connecting to power source and/or battery pack, picking up or carrying the tool.** Carrying power tools with your finger on the switch or energizing power tools that have the switch on invites accidents.
- d) **Remove any adjusting key or wrench before turning the power tool on.** A wrench or a key left attached to a rotating part of the power tool may result in personal injury.
- e) **Do not overreach.** Always keep proper footing and balance. This enables better control of the power tool in unexpected situations.
- f) **Dress properly.** Do not wear loose clothing or jewellery. Keep your hair, clothing, and gloves away from moving parts. Loose clothes, jewellery or long hair can be caught in moving parts.
- g) **If devices are provided for the connection of dust extraction and collection facilities, ensure these are connected and properly used.** Use of dust collection can reduce dust-related hazards.

### Power tool use and care

- a) **Do not force the power tool. Use the correct power tool for your application.** The correct power tool will do the job better and safer at the rate for which it was designed.
- b) **Do not use the power tool if the switch does not turn it on and off.** Any power tool that cannot be controlled with the switch is dangerous and must be repaired.
- c) **Disconnect the plug from the power source and/or the battery pack from the power tool before making any adjustments, changing accessories, or storing power tools.** Such preventive safety measures reduce the risk of starting the power tool accidentally.
- d) **Store idle power tools out of the reach of children and do not allow persons unfamiliar with the power tool or these instructions to operate the power tool.** Power tools are dangerous in the hands of untrained users.
- e) **Maintain power tools. Check for misalignment or binding of moving parts,**







**breakage of parts and any other condition that may affect the power tools operation.** If damaged, have the power tool repaired before use. Many accidents are caused by poorly maintained power tools.

- f) **Keep cutting tools sharp and clean. Properly maintained cutting tools with sharp cutting edges are less likely to bind and are easier to control.**
- g) **Use the power tool, accessories, and tool bits etc.** in accordance with these instructions, considering the working conditions and the work to be performed. Use of the power tool for operations different from those intended could result in a hazardous situation.
- h) **Have your power tool serviced by a qualified repair person using only identical.** This will ensure that the safety of the power tool is maintained.

### **Service**

- a) **Have your power tool serviced by a qualified repair person using only identical.** This will ensure that the safety of the power tool is maintained.

**THE SYMBOLS IN INSTRUCTION MANUAL**

	Double insulated for additional protection
	Read the instruction manual before using.
	CE conformity.
	Safety alert. Please only use the accessories supported by the manufacturer.
	Wear safety glasses, hearing protection and dust mask.
	Waste electrical products should not be disposed of with household waste. Please recycle where facilities exist. Check with your Local Authority or retailer for recycling advice.

## SAFETY WARNING ON USING

Instructions how to deal with harmful/toxic dusts arising from sanding e.g. lead painted surfaces, woods and metals.

These instructions shall be preceded by a warning that contacts with or inhalation of these dusts can endanger the health of operator and bystanders.

These instructions shall include the use of appropriate personal protective equipment.

## RESIDUAL RISKS

Even when the power tool is used as prescribed it is not possible to eliminate all residual risk factors. The following hazards may arise in connection with the power tool's construction and design:

- a) Health defects resulting from vibration emission if the power tool is being used over longer period of time or not adequately managed and properly maintained.
- b) Injuries and damage to property due to broken accessories that are suddenly dashed.

### Warning!

**This power tool produces an electromagnetic field during operation. This field may under some circumstances interfere with active or passive medical implants. To reduce the risk of serious or fatal injury, we recommend persons with medical implants to consult their physician and the medical implant manufacturer before operating this power tool.**

## INTENDED USE

The power tool is intended for dry sanding of wood, plastic, metal, filler and varnished surfaces

## SPECIFICATIONS

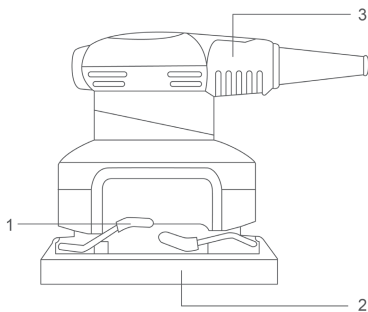

- 1.Sanding sheet clamping system  
3.Soft grip for more comfortable hold

2. Nylon plate

## Technical specifications

<b>Model No.</b>	<b>PM110SFS</b>
<b>Rated input power</b>	240W
<b>Rated voltage</b>	220V~50Hz/50Hz~60Hz
<b>No-load speed</b>	14500/min
<b>Bottom base</b>	110x110mm(4-3/8"x4")

## OPERATION PICTURE

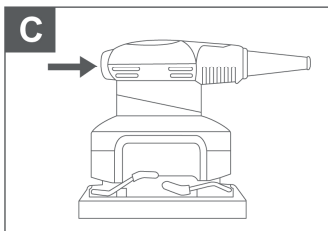
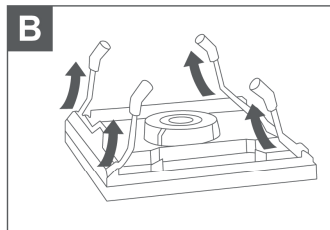
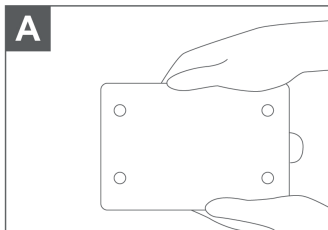



## OPERATION

### Caution

Before using the tool, read the instruction book carefully.

### **Fitting the sanding paper (see Dia A&B)**

Fit the sanding paper over the base. Make sure the sanding paper is even with the edges and that the dust collection holes in the base and sanding paper is aligned and that the sanding paper is taut on the base. (see Dia A)

Lift the sanding paper retaining clips to the open position and insert one end of the sanding paper under the retaining clip. (see Dia B)

### **Operating the on/off switch (see Dia C)**

on/off switch

Depress to start and release to stop your tool.

## MAINTENANCE&MALFUNCTIONS

### Possible malfunctions and methods of their eliminations

Malfunction	Probable causes	Actions
When the machine is turned on, the electric motor does not work.	<ul style="list-style-type: none"> <li>• Switch failure</li> <li>• The power cord or wiring is broken, power cord plug malfunction;</li> <li>• No brush contact with the collector;</li> <li>• Wear/damage of brushes</li> </ul>	Disconnect the machine from the mains and contact a qualified specialist.
Formation of a circular fire on the collector	<ul style="list-style-type: none"> <li>• Brush wear/damage of the brush holder;</li> <li>• Malfunction in the armature coil</li> </ul>	Disconnect the machine from the mains and contact a qualified specialist. Please don't repair the machine by your own.
When working, smoke or the smell of burning insulation appears from the ventilation openings.	<ul style="list-style-type: none"> <li>• Malfunction in the electric motor coil;</li> <li>• Malfunction of the electrical part of the tool.</li> </ul>	
Increased noise in the gearbox	<ul style="list-style-type: none"> <li>• Wear/breakage of gears or bearings</li> </ul>	
When the machine is turned on, the spindle does not rotate	<ul style="list-style-type: none"> <li>• Gearbox failure.</li> </ul>	

### Critical state criteria

Critical state criteria	Probable causes	Actions
Cracks on the surfaces of bearing and housing parts	Fatigue deformation of metal	Disconnect the machine from the mains and contact a qualified specialist. Please don't repair the machine by your own.
The power cord or plug is damaged	Overload or breakage	
Excessive wear or damage to the motor or reductor mechanism, or a combination of signs	Fatigue deformation of metal	

### Critical state criteria

List of critical failures	Actions
Electric motor sparking	It is necessary to contact a qualified specialist
The appearance of extraneous noise	It is necessary to contact a qualified specialist
If the above malfunctions are detected, it is necessary to disconnect the machine from the mains and contact a qualified specialist	

# **Polymak**<sup>®</sup>

**Polymak Tools(India)Pvt.Ltd**

186/187, P.H Road,Alsa Towers,Kilpauk,  
Chennai – 600 010,

Tel. : +91-44-48631869

E-mail : info@polymak.co.in

Visit us at : [www.polymak.co.in](http://www.polymak.co.in)